

No.	DESCRIPTION	
1	FIBER CONCRETE/GFRP PANEL	
2	J-CHANNEL	
3	HAT-CHANNEL	-NOT USED
4	ADJUSTABLE BRACKET	-NOT USED
5	FIXED BRACKET	-NOT USED
6	PANEL FASTENER	
7	PANEL RIVET	-NOT USED
8	RAIL ANCHOR	-NOT USED
9	RAIL	-NOT USED
10	SYSTEM CLOSURE	-NOT USED
11	VENT SCREEN	-NOT USED
12	CLOSURE FASTENER	-NOT USED
13	CORNER CLOSE	-NOT USED
14	JOINT CLOSURE	-NOT USED
15	HORIZONTAL BRACKET	-NOT USED
16	THERMAL ISOLATOR	-NOT USED

	MATERIALS
A	WEATHER BARRIER
B	CHANNEL ANCHOR
C	SHEATHING
D	STEEL BACKING PLATE

PROPRIETARY AND CONFIDENTIAL THE INFORMATION CONTAINED IN THIS DRAWING IS THE SOLE PROPERTY OF MONARCH METAL FABRICATION. ANY REPRODUCTION IN PART OR AS A WHOLE WITHOUT THE WRITTEN PERMISSION OF MONARCH METAL FABRICATION IS PROHIBITED. DO NOT SCALE DRAWING		NAME	DATE
	MATERIAL	DRAWN KP	11/20/20
	FINISH	CHECKED BB	
		COMMENTS:	



TITLE:
FIBER CONCRETE/GFRP VERTICAL EXPOSED W/O THERMAL ISOLATION

SIZE A	DWG. NO. DOOR JAMB	REV A
SCALE: 6" = 1'-0"		SHEET 1 OF 16

5

4

3

2

1

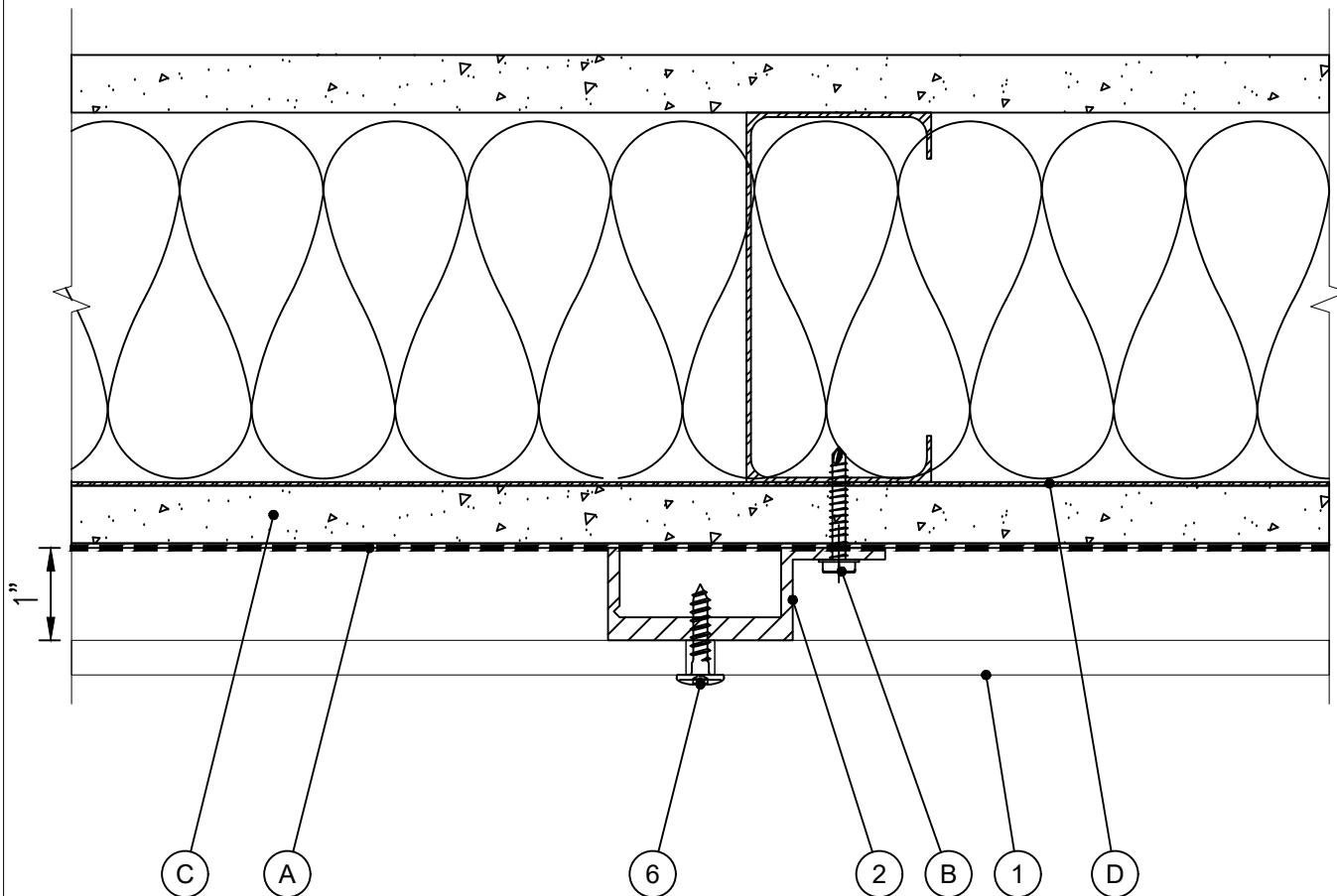

No.	DESCRIPTION	
1	FIBER CONCRETE/GFRP PANEL	
2	J-CHANNEL	
3	HAT-CHANNEL	-NOT USED
4	ADJUSTABLE BRACKET	-NOT USED
5	FIXED BRACKET	-NOT USED
6	PANEL FASTENER	
7	PANEL RIVET	-NOT USED
8	RAIL ANCHOR	-NOT USED
9	RAIL	-NOT USED
10	SYSTEM CLOSURE	-NOT USED
11	VENT SCREEN	-NOT USED
12	CLOSURE FASTENER	-NOT USED
13	CORNER CLOSE	-NOT USED
14	JOINT CLOSURE	-NOT USED
15	HORIZONTAL BRACKET	-NOT USED
16	THERMAL ISOLATOR	-NOT USED

	MATERIALS
A	WEATHER BARRIER
B	CHANNEL ANCHOR
C	SHEATHING
D	STEEL BACKING PLATE



TITLE:
FIBER CONCRETE/GFRP VERTICAL EXPOSED W/O THERMAL ISOLATION

SIZE	DWG. NO.	REV
A	VERT. MID PANEL	A
SCALE: 6" = 1'-0"		SHEET 3 OF 16

PROPRIETARY AND CONFIDENTIAL THE INFORMATION CONTAINED IN THIS DRAWING IS THE SOLE PROPERTY OF MONARCH METAL FABRICATION. ANY REPRODUCTION IN PART OR AS A WHOLE WITHOUT THE WRITTEN PERMISSION OF MONARCH METAL FABRICATION IS PROHIBITED. DO NOT SCALE DRAWING		NAME	DATE
	MATERIAL	DRAWN	KP 11/20/20
	FINISH	CHECKED	BB
		COMMENTS:	

5

4

3

2

1

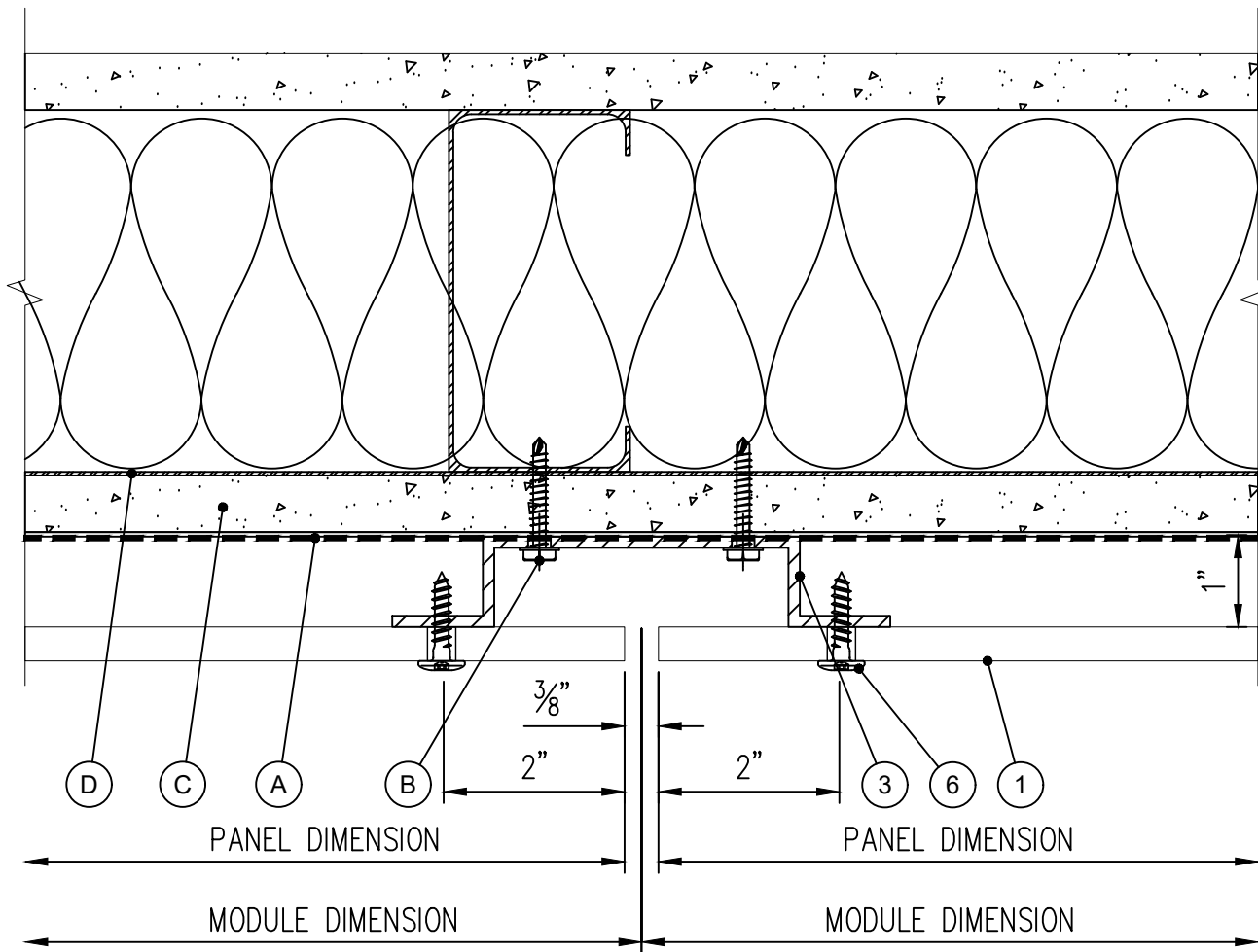

No.	DESCRIPTION	
1	FIBER CONCRETE/GFRC PANEL	
2	J-CHANNEL	-NOT USED
3	HAT-CHANNEL	
4	ADJUSTABLE BRACKET	-NOT USED
5	FIXED BRACKET	-NOT USED
6	PANEL FASTENER	
7	PANEL RIVET	-NOT USED
8	RAIL ANCHOR	-NOT USED
9	RAIL	-NOT USED
10	SYSTEM CLOSURE	-NOT USED
11	VENT SCREEN	-NOT USED
12	CLOSURE FASTENER	-NOT USED
13	CORNER CLOSE	-NOT USED
14	JOINT CLOSURE	-NOT USED
15	HORIZONTAL BRACKET	-NOT USED
16	THERMAL ISOLATOR	-NOT USED

MATERIALS	
A	WEATHER BARRIER
B	CHANNEL ANCHOR
C	SHEATHING
D	STEEL BACKING PLATE



TITLE:
FIBER CONCRETE/GFRC VERTICAL EXPOSED W/O THERMAL ISOLATION

SIZE A	DWG. NO. VERT. PANEL JOINT	REV A
-----------	-------------------------------	----------

SCALE: 6" = 1'-0"

SHEET 4 OF 16

PROPRIETARY AND CONFIDENTIAL THE INFORMATION CONTAINED IN THIS DRAWING IS THE SOLE PROPERTY OF MONARCH METAL FABRICATION. ANY REPRODUCTION IN PART OR AS A WHOLE WITHOUT THE WRITTEN PERMISSION OF MONARCH METAL FABRICATION IS PROHIBITED. DO NOT SCALE DRAWING		NAME	DATE
	MATERIAL	DRAWN	KP 11/20/20
	FINISH	CHECKED	BB
		COMMENTS:	

5

4

3

2

1

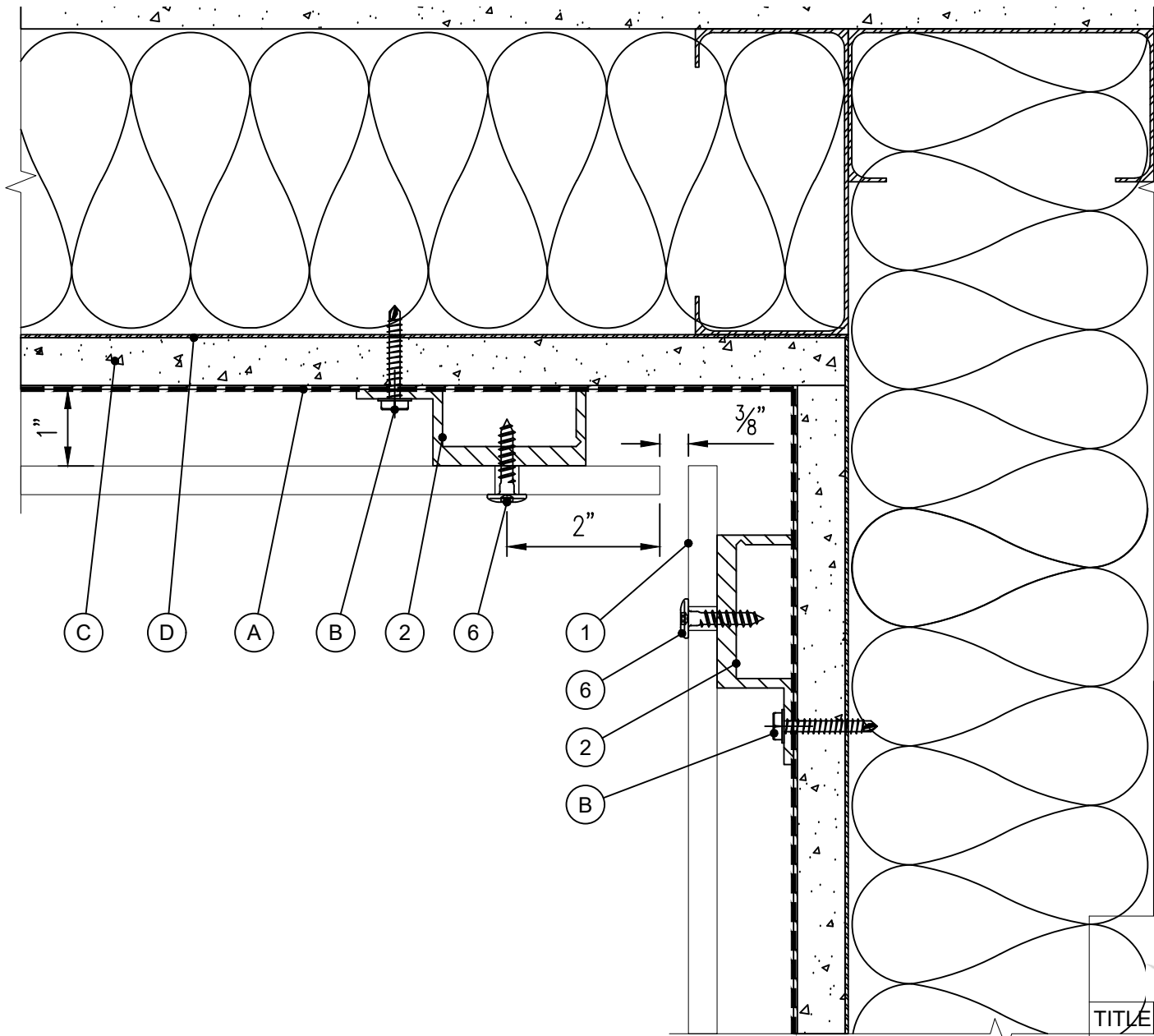

No.	DESCRIPTION	
1	FIBER CONCRETE/GFRC PANEL	
2	J-CHANNEL	
3	HAT-CHANNEL	-NOT USED
4	ADJUSTABLE BRACKET	-NOT USED
5	FIXED BRACKET	-NOT USED
6	PANEL FASTENER	
7	PANEL RIVET	-NOT USED
8	RAIL ANCHOR	-NOT USED
9	RAIL	-NOT USED
10	SYSTEM CLOSURE	-NOT USED
11	VENT SCREEN	-NOT USED
12	CLOSURE FASTENER	-NOT USED
13	CORNER CLOSE	-NOT USED
14	JOINT CLOSURE	-NOT USED
15	HORIZONTAL BRACKET	-NOT USED
16	THERMAL ISOLATOR	-NOT USED

MATERIALS	
A	WEATHER BARRIER
B	CHANNEL ANCHOR
C	SHEATHING
D	STEEL BACKING PLATE



TITLE: FIBER CONCRETE/GFRC VERTICAL EXPOSED W/O THERMAL ISOLATION

PROPRIETARY AND CONFIDENTIAL
 THE INFORMATION CONTAINED IN THIS DRAWING IS THE SOLE PROPERTY OF MONARCH METAL FABRICATION. ANY REPRODUCTION IN PART OR AS A WHOLE WITHOUT THE WRITTEN PERMISSION OF MONARCH METAL FABRICATION IS PROHIBITED.

MATERIAL	NAME	DATE
FINISH	DRAWN	KP 11/20/20
DO NOT SCALE DRAWING	CHECKED	BB
	COMMENTS:	

SIZE	DWG. NO.	REV
A	INSIDE CORNER	A
SCALE: 6" = 1'-0"		SHEET 6 OF 16

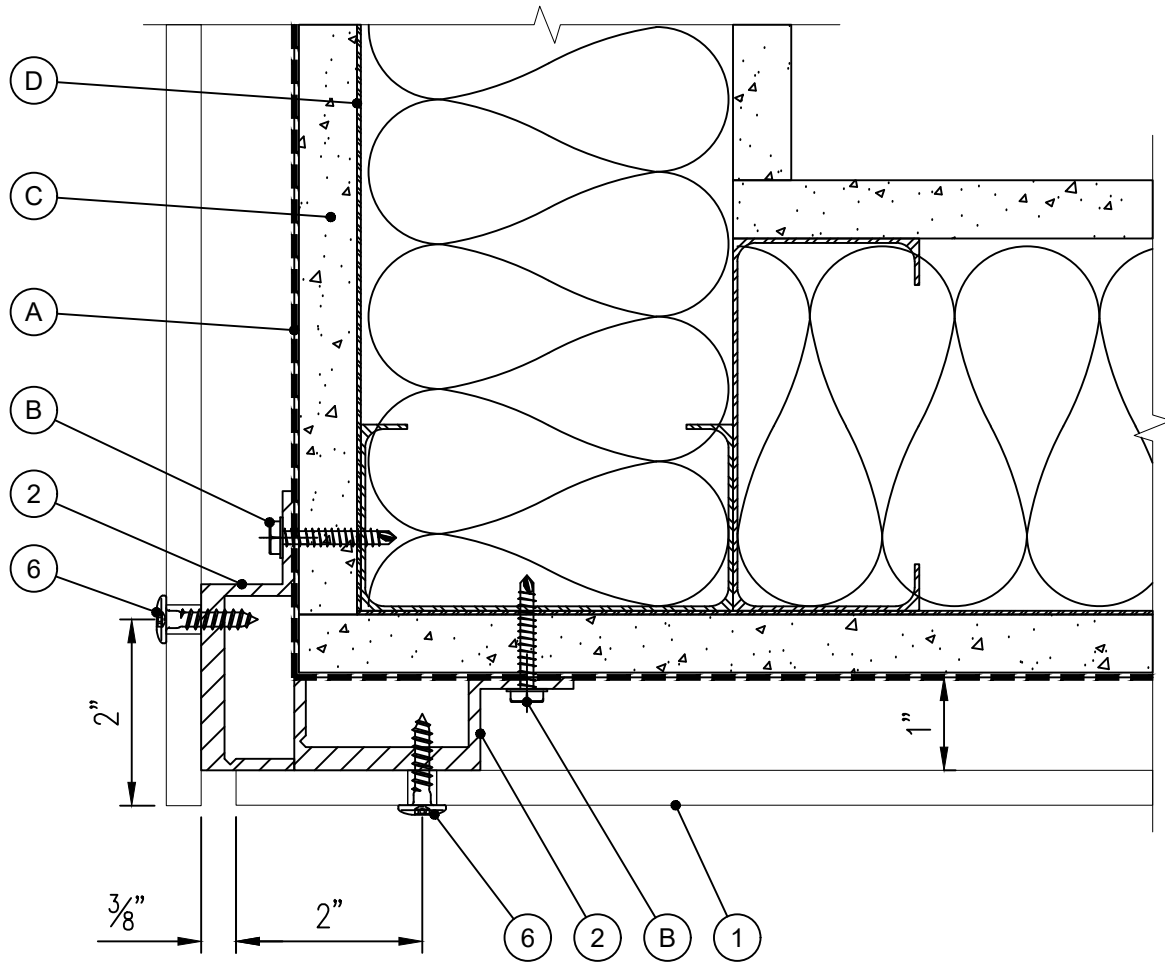

No.	DESCRIPTION	
1	FIBER CONCRETE/GFRP PANEL	
2	J-CHANNEL	
3	HAT-CHANNEL	-NOT USED
4	ADJUSTABLE BRACKET	-NOT USED
5	FIXED BRACKET	-NOT USED
6	PANEL FASTENER	
7	PANEL RIVET	-NOT USED
8	RAIL ANCHOR	-NOT USED
9	RAIL	-NOT USED
10	SYSTEM CLOSURE	-NOT USED
11	VENT SCREEN	-NOT USED
12	CLOSURE FASTENER	-NOT USED
13	CORNER CLOSE	-NOT USED
14	JOINT CLOSURE	-NOT USED
15	HORIZONTAL BRACKET	-NOT USED
16	THERMAL ISOLATOR	-NOT USED

MATERIALS	
A	WEATHER BARRIER
B	CHANNEL ANCHOR
C	SHEATHING
D	STEEL BACKING PLATE

PROPRIETARY AND CONFIDENTIAL THE INFORMATION CONTAINED IN THIS DRAWING IS THE SOLE PROPERTY OF MONARCH METAL FABRICATION. ANY REPRODUCTION IN PART OR AS A WHOLE WITHOUT THE WRITTEN PERMISSION OF MONARCH METAL FABRICATION IS PROHIBITED. DO NOT SCALE DRAWING		NAME	DATE
	MATERIAL	DRAWN	KP 11/20/20
	FINISH	CHECKED	BB
		COMMENTS:	



TITLE:
 FIBER CONCRETE/GFRP VERTICAL EXPOSED W/O THERMAL ISOLATION

SIZE A	DWG. NO. OUTSIDE CORNER	REV A
SCALE: 6" = 1'-0"		SHEET 7 OF 16

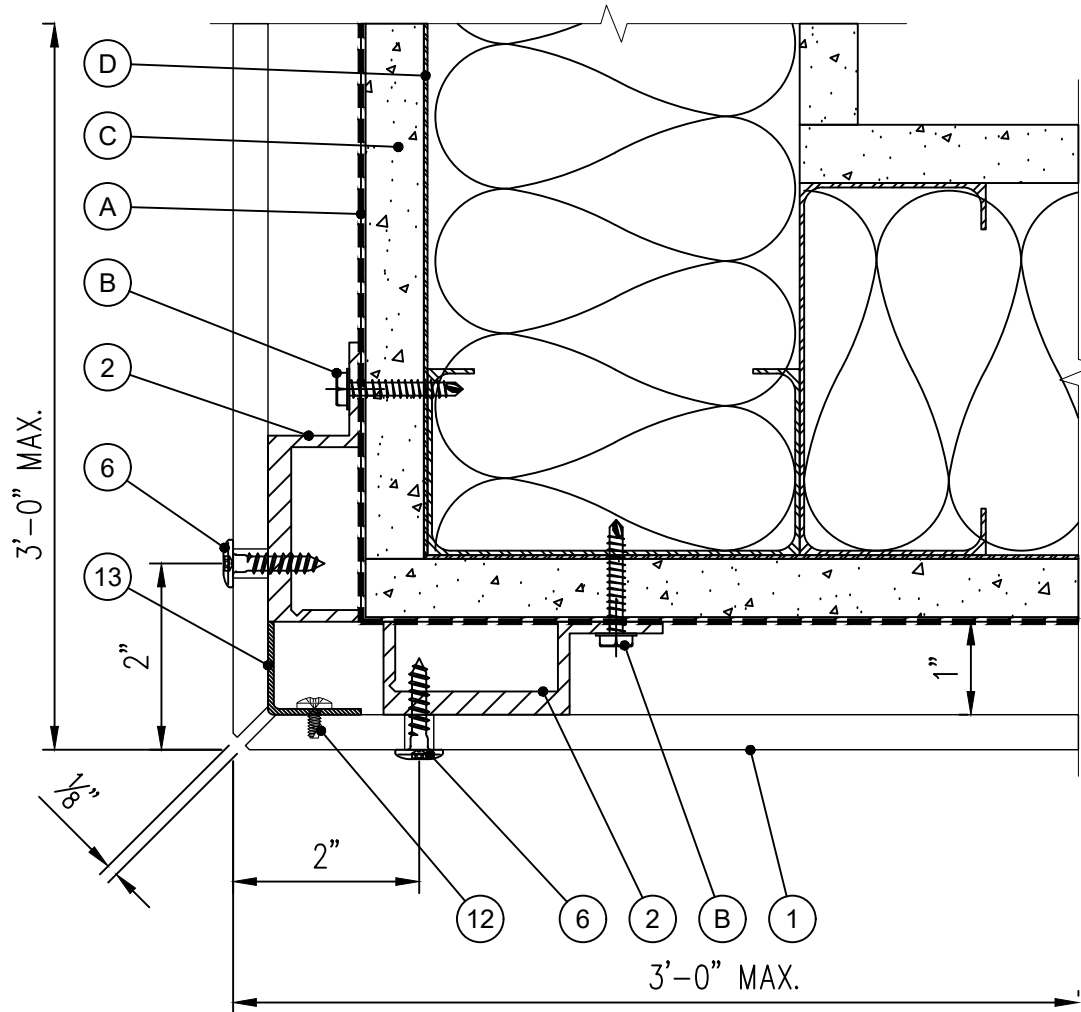

No.	DESCRIPTION	
1	FIBER CONCRETE/GFRP PANEL	
2	J-CHANNEL	
3	HAT-CHANNEL	-NOT USED
4	ADJUSTABLE BRACKET	-NOT USED
5	FIXED BRACKET	-NOT USED
6	PANEL FASTENER	
7	PANEL RIVET	-NOT USED
8	RAIL ANCHOR	-NOT USED
9	RAIL	-NOT USED
10	SYSTEM CLOSURE	-NOT USED
11	VENT SCREEN	-NOT USED
12	CLOSURE FASTENER	
13	CORNER CLOSE	
14	JOINT CLOSURE	-NOT USED
15	HORIZONTAL BRACKET	-NOT USED
16	THERMAL ISOLATOR	-NOT USED

MATERIALS	
A	WEATHER BARRIER
B	CHANNEL ANCHOR
C	SHEATHING
D	STEEL BACKING PLATE



TITLE:
FIBER CONCRETE/GFRP VERTICAL EXPOSED W/O THERMAL ISOLATION

SIZE **A** DWG. NO. **MITERED CORNER** REV **A**

SCALE: 6" = 1'-0"

SHEET 8 OF 16

PROPRIETARY AND CONFIDENTIAL THE INFORMATION CONTAINED IN THIS DRAWING IS THE SOLE PROPERTY OF MONARCH METAL FABRICATION. ANY REPRODUCTION IN PART OR AS A WHOLE WITHOUT THE WRITTEN PERMISSION OF MONARCH METAL FABRICATION IS PROHIBITED. DO NOT SCALE DRAWING		NAME	DATE
	MATERIAL	DRAWN	KP 11/20/20
	FINISH	CHECKED	BB
		COMMENTS:	

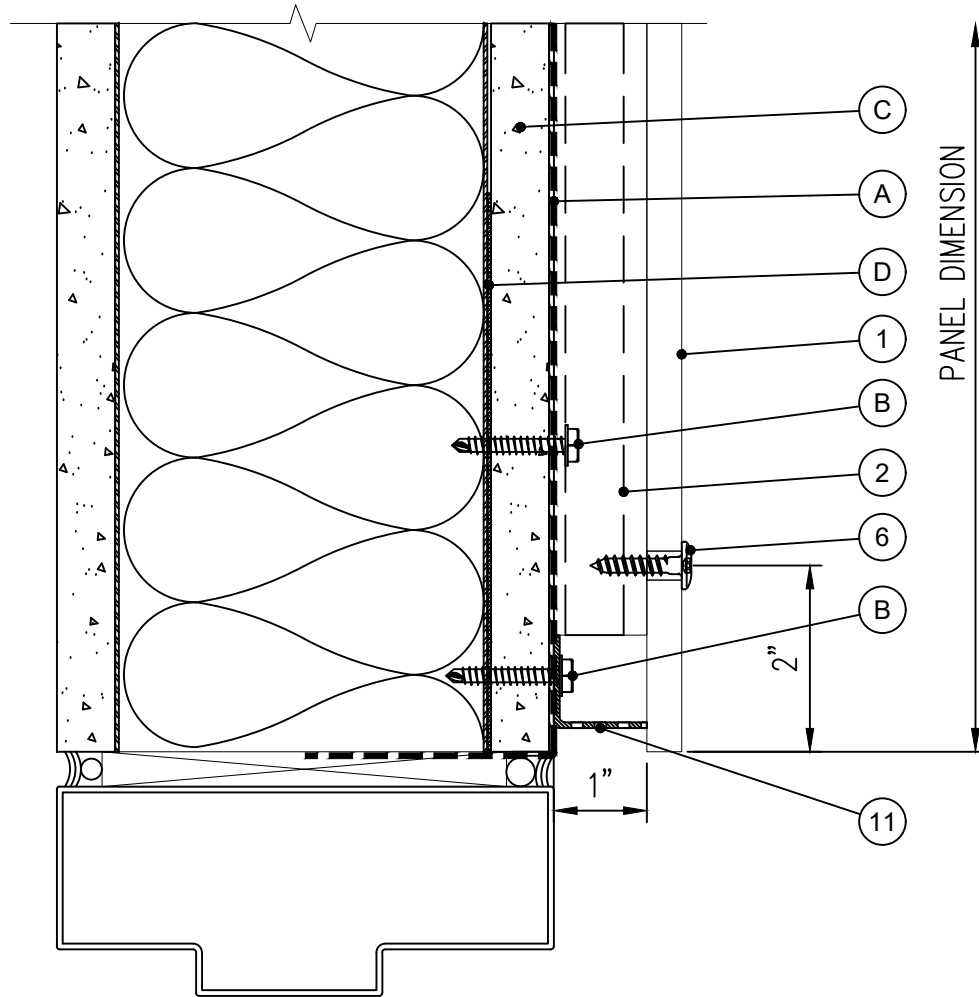

No.	DESCRIPTION	
1	FIBER CONCRETE/GFRP PANEL	
2	J-CHANNEL	
3	HAT-CHANNEL	-NOT USED
4	ADJUSTABLE BRACKET	-NOT USED
5	FIXED BRACKET	-NOT USED
6	PANEL FASTENER	
7	PANEL RIVET	-NOT USED
8	RAIL ANCHOR	-NOT USED
9	RAIL	-NOT USED
10	SYSTEM CLOSURE	-NOT USED
11	VENT SCREEN	
12	CLOSURE FASTENER	-NOT USED
13	CORNER CLOSE	-NOT USED
14	JOINT CLOSURE	-NOT USED
15	HORIZONTAL BRACKET	-NOT USED
16	THERMAL ISOLATOR	-NOT USED

MATERIALS	
A	WEATHER BARRIER
B	CHANNEL ANCHOR
C	SHEATHING
D	STEEL BACKING PLATE

PROPRIETARY AND CONFIDENTIAL THE INFORMATION CONTAINED IN THIS DRAWING IS THE SOLE PROPERTY OF MONARCH METAL FABRICATION. ANY REPRODUCTION IN PART OR AS A WHOLE WITHOUT THE WRITTEN PERMISSION OF MONARCH METAL FABRICATION IS PROHIBITED. DO NOT SCALE DRAWING		NAME	DATE
	MATERIAL	DRAWN	KP 11/20/20
	FINISH	CHECKED	BB
		COMMENTS:	



TITLE:
FIBER CONCRETE/GFRP VERTICAL EXPOSED W/O THERMAL ISOLATION

SIZE A	DWG. NO. DOOR HEAD	REV A
SCALE: 6" = 1'-0"		SHEET 9 OF 16

5

4

3

2

1

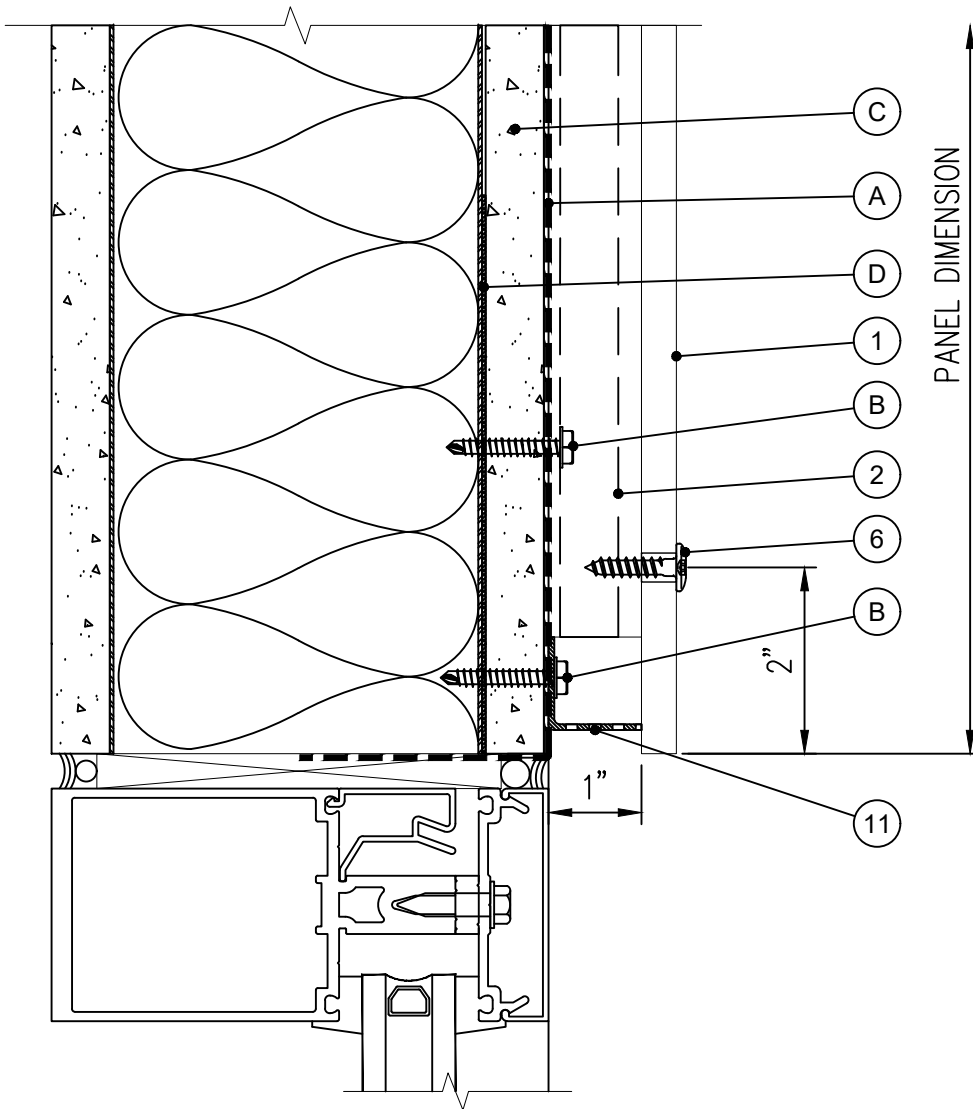

No.	DESCRIPTION	
1	FIBER CONCRETE/GFRP PANEL	
2	J-CHANNEL	
3	HAT-CHANNEL	-NOT USED
4	ADJUSTABLE BRACKET	-NOT USED
5	FIXED BRACKET	-NOT USED
6	PANEL FASTENER	
7	PANEL RIVET	-NOT USED
8	RAIL ANCHOR	-NOT USED
9	RAIL	-NOT USED
10	SYSTEM CLOSURE	-NOT USED
11	VENT SCREEN	
12	CLOSURE FASTENER	-NOT USED
13	CORNER CLOSE	-NOT USED
14	JOINT CLOSURE	-NOT USED
15	HORIZONTAL BRACKET	-NOT USED
16	THERMAL ISOLATOR	-NOT USED

MATERIALS	
A	WEATHER BARRIER
B	CHANNEL ANCHOR
C	SHEATHING
D	STEEL BACKING PLATE



TITLE:
FIBER CONCRETE/GFRP VERTICAL
EXPOSED W/O THERMAL ISOLATION

SIZE DWG. NO. REV
A WINDOW HEAD A

SCALE: 6" = 1'-0"

SHEET 10 OF 16

PROPRIETARY AND CONFIDENTIAL
THE INFORMATION CONTAINED IN THIS
DRAWING IS THE SOLE PROPERTY OF
MONARCH METAL FABRICATION. ANY
REPRODUCTION IN PART OR AS A WHOLE
WITHOUT THE WRITTEN PERMISSION OF
MONARCH METAL FABRICATION IS PROHIBITED.

MATERIAL
FINISH
DO NOT SCALE DRAWING

	NAME	DATE
DRAWN	KP	11/20/20
CHECKED	BB	
COMMENTS:		

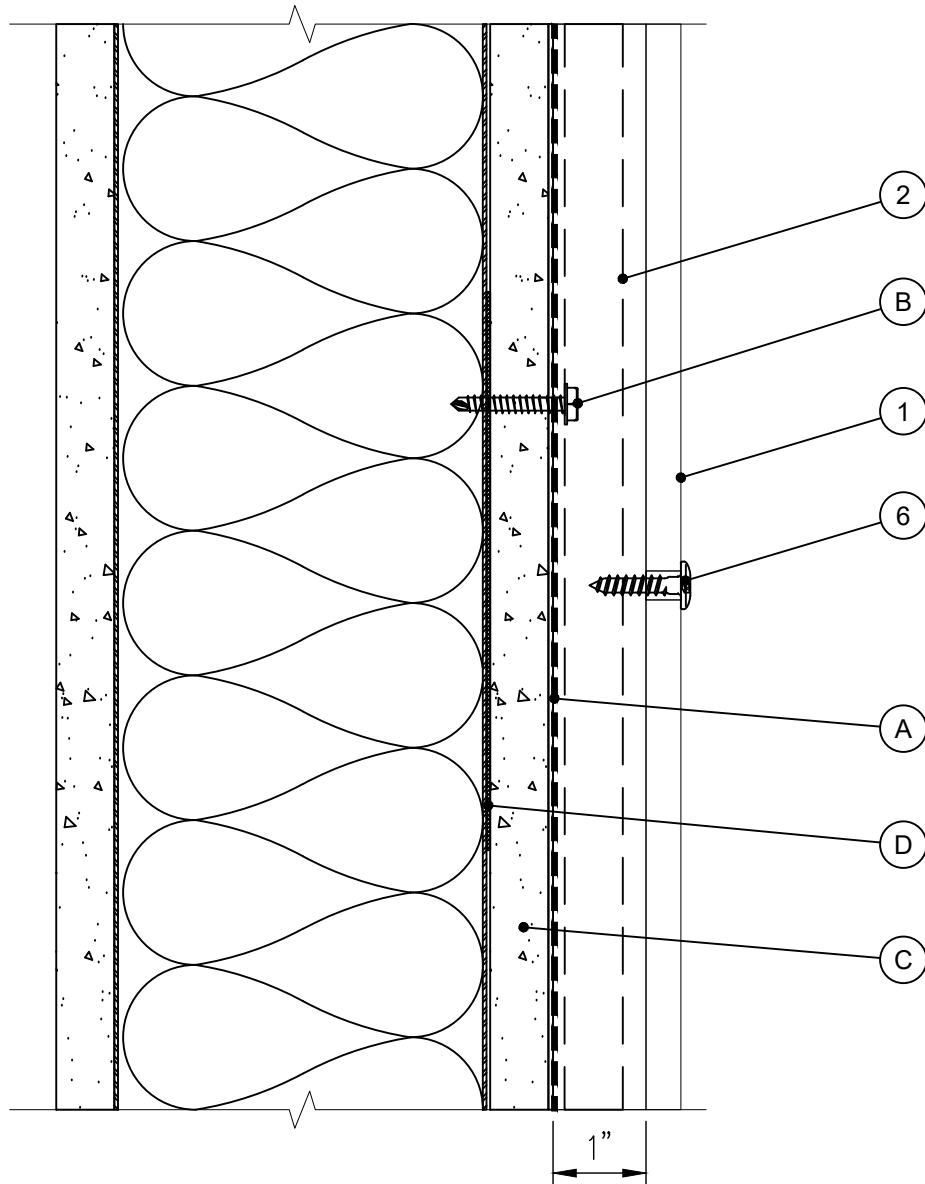

No.	DESCRIPTION	
1	FIBER CONCRETE/GFRP PANEL	
2	J-CHANNEL	
3	HAT-CHANNEL	-NOT USED
4	ADJUSTABLE BRACKET	-NOT USED
5	FIXED BRACKET	-NOT USED
6	PANEL FASTENER	
7	PANEL RIVET	-NOT USED
8	RAIL ANCHOR	-NOT USED
9	RAIL	-NOT USED
10	SYSTEM CLOSURE	-NOT USED
11	VENT SCREEN	-NOT USED
12	CLOSURE FASTENER	-NOT USED
13	CORNER CLOSE	-NOT USED
14	JOINT CLOSURE	-NOT USED
15	HORIZONTAL BRACKET	-NOT USED
16	THERMAL ISOLATOR	-NOT USED

MATERIALS	
A	WEATHER BARRIER
B	CHANNEL ANCHOR
C	SHEATHING
D	STEEL BACKING PLATE

PROPRIETARY AND CONFIDENTIAL THE INFORMATION CONTAINED IN THIS DRAWING IS THE SOLE PROPERTY OF MONARCH METAL FABRICATION. ANY REPRODUCTION IN PART OR AS A WHOLE WITHOUT THE WRITTEN PERMISSION OF MONARCH METAL FABRICATION IS PROHIBITED. DO NOT SCALE DRAWING	MATERIAL	NAME	DATE
	FINISH	DRAWN	KP 11/20/20
		CHECKED	BB
		COMMENTS:	



TITLE:
FIBER CONCRETE/GFRP VERTICAL EXPOSED W/O THERMAL ISOLATION

SIZE A	DWG. NO. HOR. MID PANEL	REV A
SCALE: 6" = 1'-0"		SHEET 11 OF 16

5

4

3

2

1

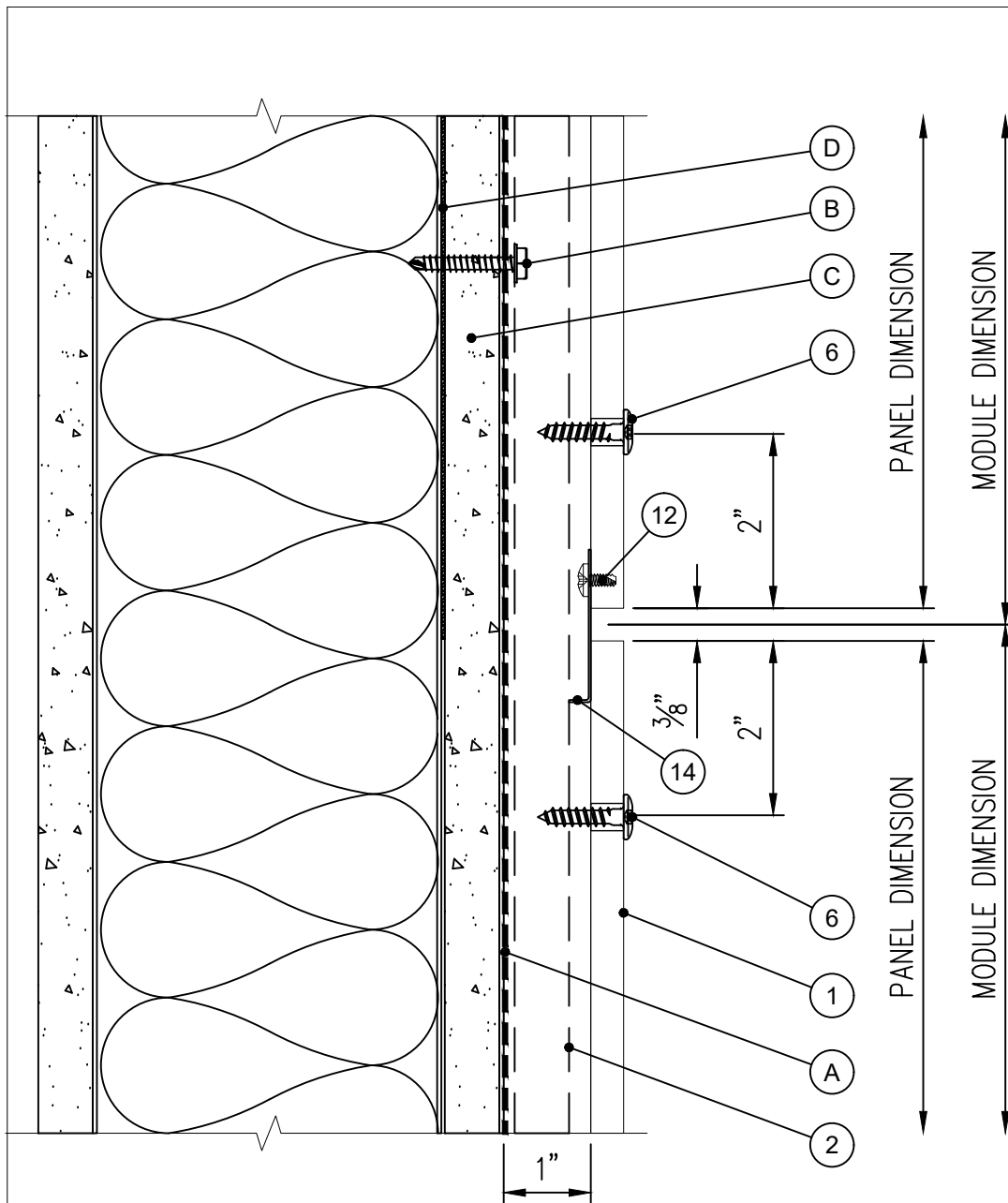

No.	DESCRIPTION	
1	FIBER CONCRETE/GFRP PANEL	
2	J-CHANNEL	
3	HAT-CHANNEL	-NOT USED
4	ADJUSTABLE BRACKET	-NOT USED
5	FIXED BRACKET	-NOT USED
6	PANEL FASTENER	
7	PANEL RIVET	-NOT USED
8	RAIL ANCHOR	-NOT USED
9	RAIL	-NOT USED
10	SYSTEM CLOSURE	-NOT USED
11	VENT SCREEN	-NOT USED
12	CLOSURE FASTENER	
13	CORNER CLOSE	-NOT USED
14	JOINT CLOSURE	
15	HORIZONTAL BRACKET	-NOT USED
16	THERMAL ISOLATOR	-NOT USED

MATERIALS	
A	WEATHER BARRIER
B	CHANNEL ANCHOR
C	SHEATHING
D	STEEL BACKING PLATE

PROPRIETARY AND CONFIDENTIAL
 THE INFORMATION CONTAINED IN THIS DRAWING IS THE SOLE PROPERTY OF MONARCH METAL FABRICATION. ANY REPRODUCTION IN PART OR AS A WHOLE WITHOUT THE WRITTEN PERMISSION OF MONARCH METAL FABRICATION IS PROHIBITED.

MATERIAL
 FINISH
 DO NOT SCALE DRAWING

	NAME	DATE
DRAWN	KP	11/20/20
CHECKED	BB	
COMMENTS:		



TITLE:
FIBER CONCRETE/GFRP VERTICAL EXPOSED W/O THERMAL ISOLATION

SIZE A	DWG. NO. HOR. PANEL JOINT	REV A
SCALE: 6" = 1'-0"		SHEET 13 OF 16

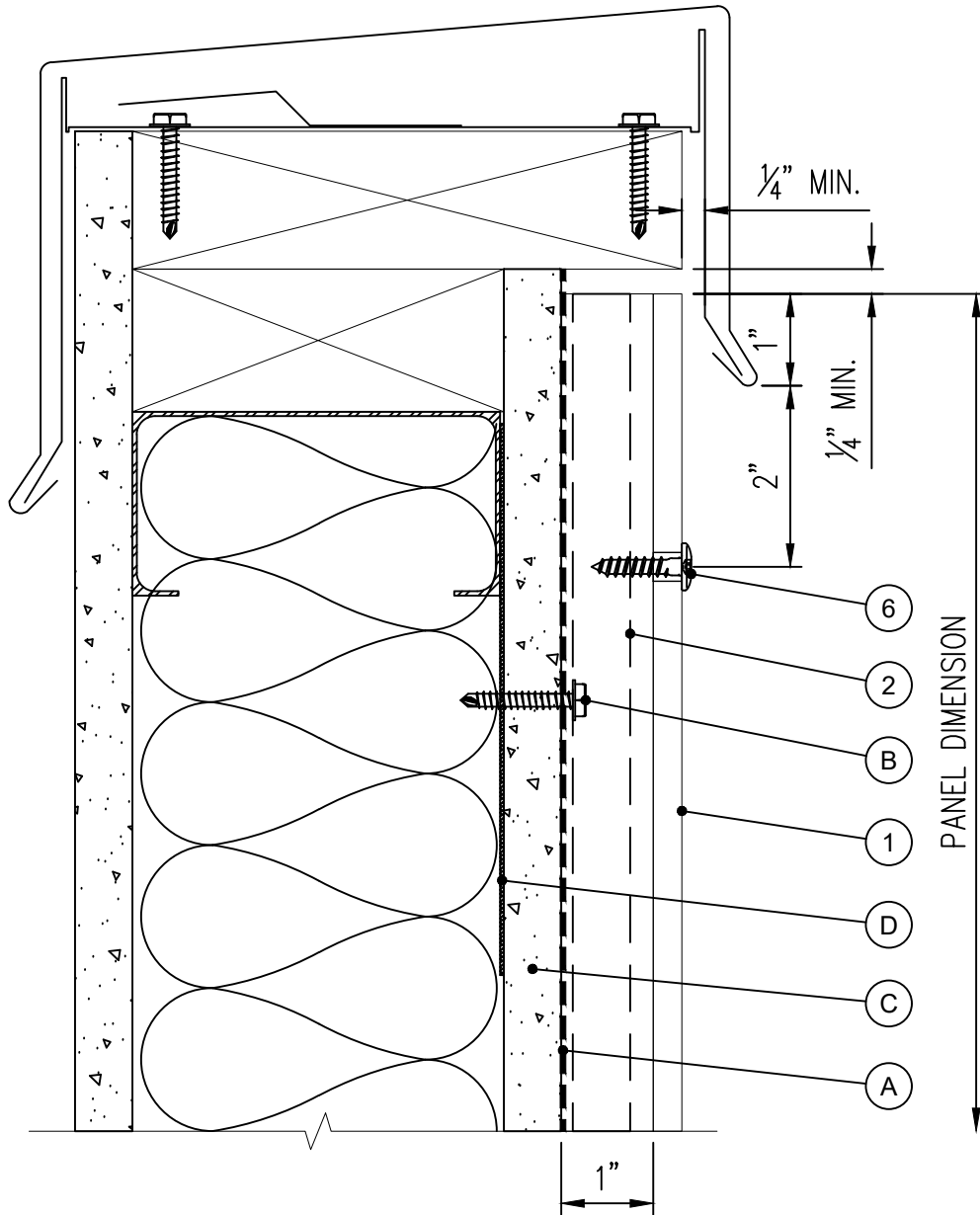

No.	DESCRIPTION	
1	FIBER CONCRETE/GFRP PANEL	
2	J-CHANNEL	
3	HAT-CHANNEL	-NOT USED
4	ADJUSTABLE BRACKET	-NOT USED
5	FIXED BRACKET	-NOT USED
6	PANEL FASTENER	
7	PANEL RIVET	-NOT USED
8	RAIL ANCHOR	-NOT USED
9	RAIL	-NOT USED
10	SYSTEM CLOSURE	-NOT USED
11	VENT SCREEN	-NOT USED
12	CLOSURE FASTENER	-NOT USED
13	CORNER CLOSE	-NOT USED
14	JOINT CLOSURE	-NOT USED
15	HORIZONTAL BRACKET	-NOT USED
16	THERMAL ISOLATOR	-NOT USED

MATERIALS	
A	WEATHER BARRIER
B	CHANNEL ANCHOR
C	SHEATHING
D	STEEL BACKING PLATE

PROPRIETARY AND CONFIDENTIAL THE INFORMATION CONTAINED IN THIS DRAWING IS THE SOLE PROPERTY OF MONARCH METAL FABRICATION. ANY REPRODUCTION IN PART OR AS A WHOLE WITHOUT THE WRITTEN PERMISSION OF MONARCH METAL FABRICATION IS PROHIBITED. DO NOT SCALE DRAWING	MATERIAL	NAME	DATE
	FINISH	DRAWN	KP 11/20/20
		CHECKED	BB
		COMMENTS:	



TITLE:
FIBER CONCRETE/GFRP VERTICAL EXPOSED W/O THERMAL ISOLATION

SIZE A	DWG. NO. PARAPET CAP	REV A
SCALE: 6" = 1'-0"		SHEET 15 OF 16

5

4

3

2

1

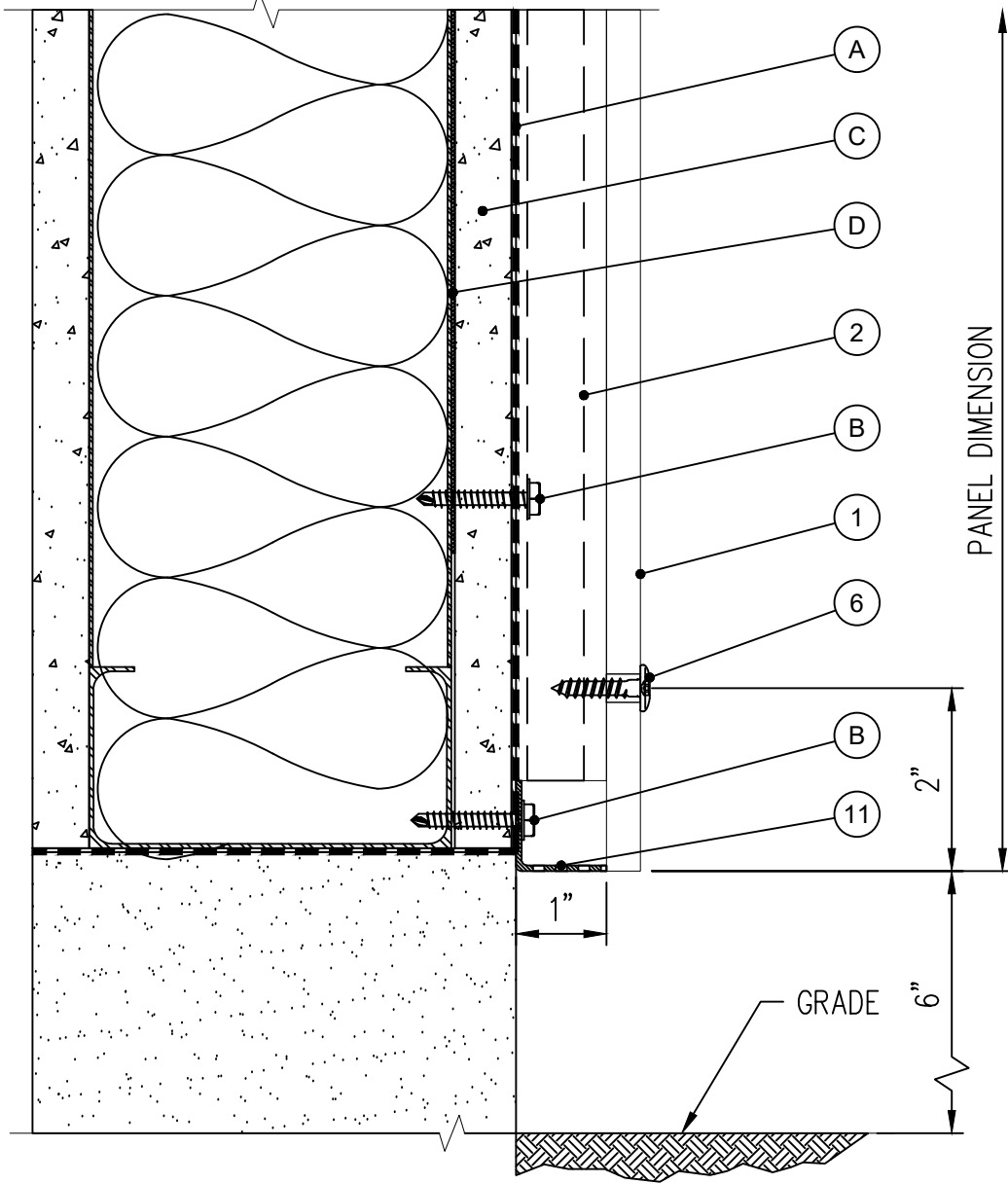

No.	DESCRIPTION	
1	FIBER CONCRETE/GFRP PANEL	
2	J-CHANNEL	
3	HAT-CHANNEL	-NOT USED
4	ADJUSTABLE BRACKET	-NOT USED
5	FIXED BRACKET	-NOT USED
6	PANEL FASTENER	
7	PANEL RIVET	-NOT USED
8	RAIL ANCHOR	-NOT USED
9	RAIL	-NOT USED
10	SYSTEM CLOSURE	-NOT USED
11	VENT SCREEN	
12	CLOSURE FASTENER	-NOT USED
13	CORNER CLOSE	-NOT USED
14	JOINT CLOSURE	-NOT USED
15	HORIZONTAL BRACKET	-NOT USED
16	THERMAL ISOLATOR	-NOT USED

	MATERIALS
A	WEATHER BARRIER
B	CHANNEL ANCHOR
C	SHEATHING
D	STEEL BACKING PLATE



TITLE:
FIBER CONCRETE/GFRP VERTICAL EXPOSED W/O THERMAL ISOLATION

PROPRIETARY AND CONFIDENTIAL THE INFORMATION CONTAINED IN THIS DRAWING IS THE SOLE PROPERTY OF MONARCH METAL FABRICATION. ANY REPRODUCTION IN PART OR AS A WHOLE WITHOUT THE WRITTEN PERMISSION OF MONARCH METAL FABRICATION IS PROHIBITED. DO NOT SCALE DRAWING	MATERIAL	NAME	DATE
	FINISH	DRAWN	KP 11/20/20
		CHECKED	BB
		COMMENTS:	

SIZE	DWG. NO.	REV
A	FLOOR BASE PANEL	A
SCALE: 6" = 1'-0"		SHEET 16 OF 16