

F MAX Hat

Horizontal Wall Bracket

Thermal Isolator

Panel

L Rail

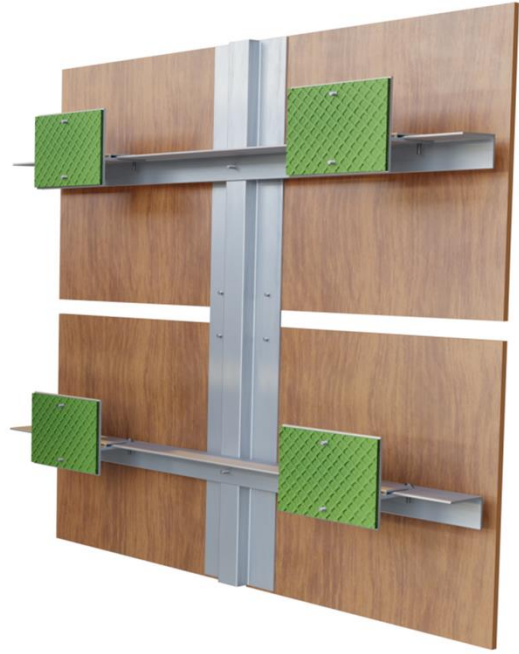
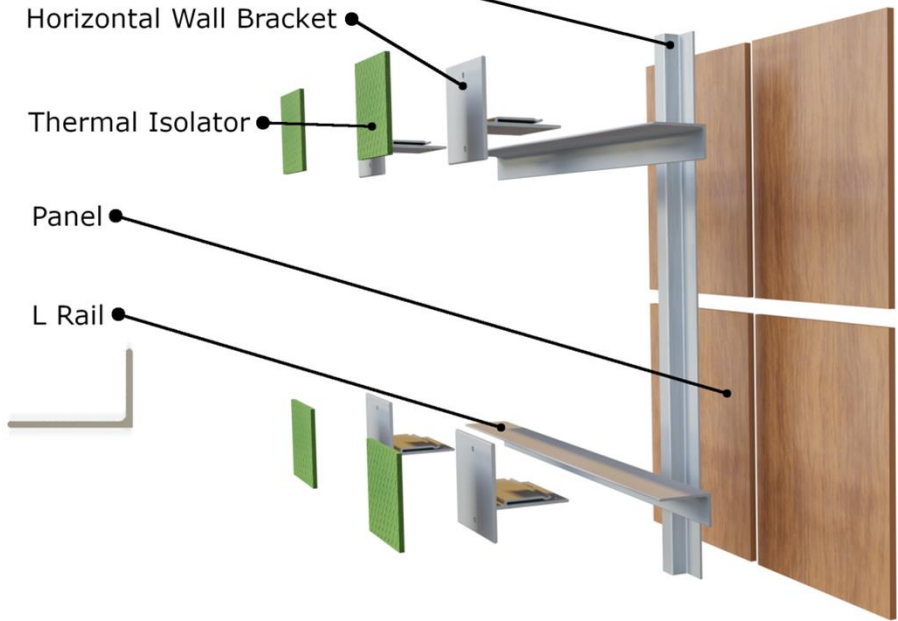

Title	Horizontal Wall Bracket Assembly
-------	----------------------------------

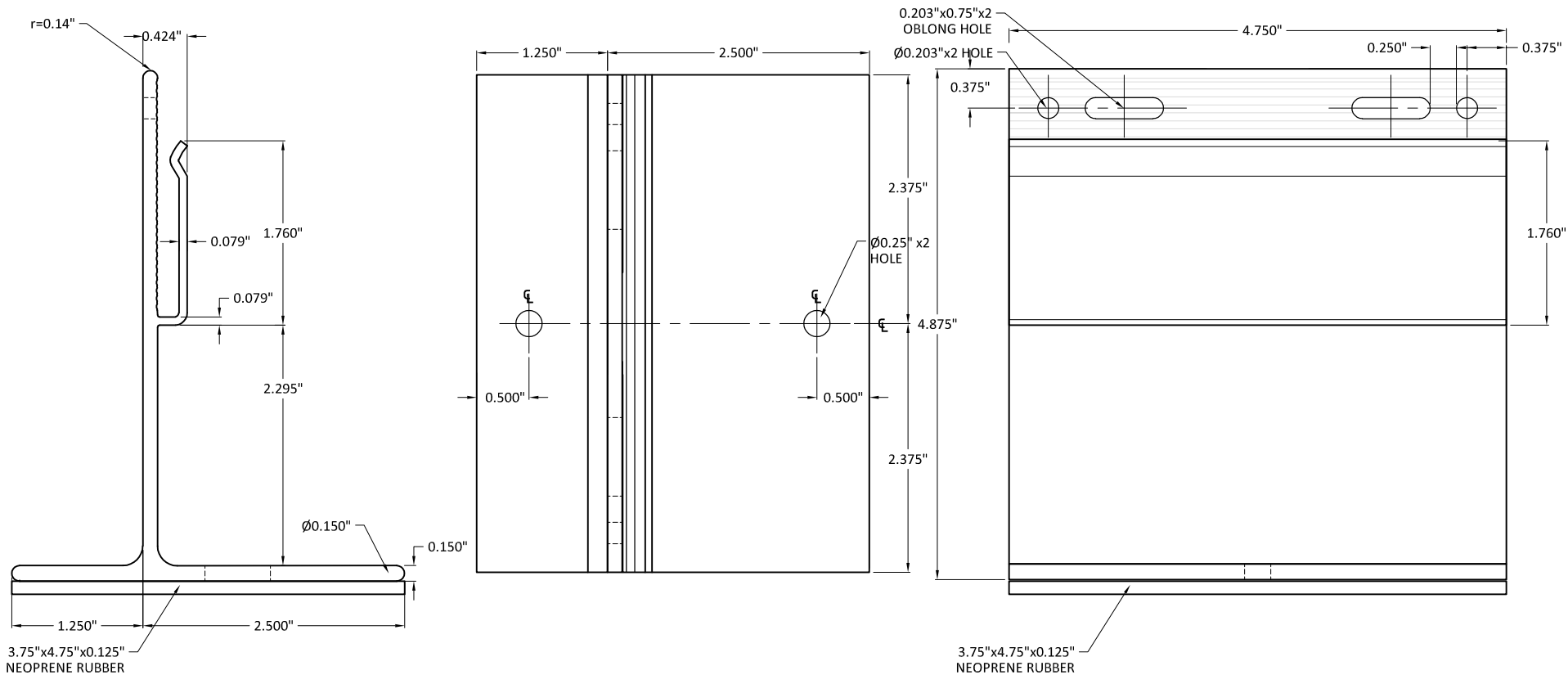

SIDE VIEW

TOP VIEW

FRONT VIEW

This drawing package is for mounting to wood and metal studs. Please let Monarch Metal know if you need drawings for CMU.



PROPRIETARY AND CONFIDENTIAL
 THE INFORMATION CONTAINED IN THIS DRAWING IS THE SOLE PROPERTY OF MONARCH METAL FABRICATION. ANY REPRODUCTION IN PART OR AS A WHOLE WITHOUT THE WRITTEN PERMISSION OF MONARCH METAL FABRICATION IS PROHIBITED.

MATERIAL
6061-T6 Aluminum
 FINISH
Mill
 DO NOT SCALE DRAWING

	NAME	DATE
DRAWN	ETC	09/04/19
CHECKED	CS	
COMMENTS:		

TITLE: Horizontal Single Wall Bracket - 5 inch		
SIZE A4	DWG. NO. HWB-05-1X	REV A
SCALE: 1:1.5	WEIGHT:	SHEET 1 OF 1

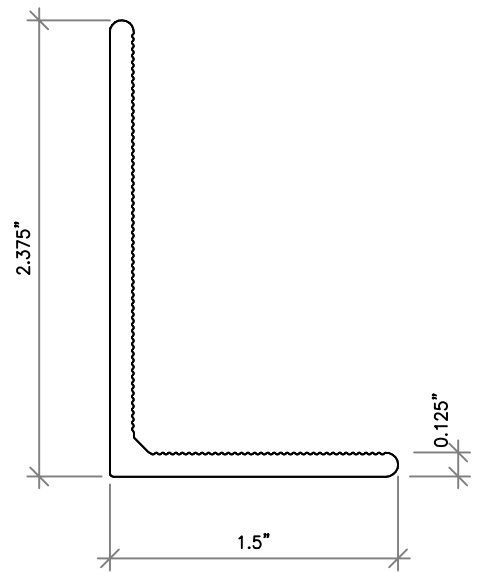
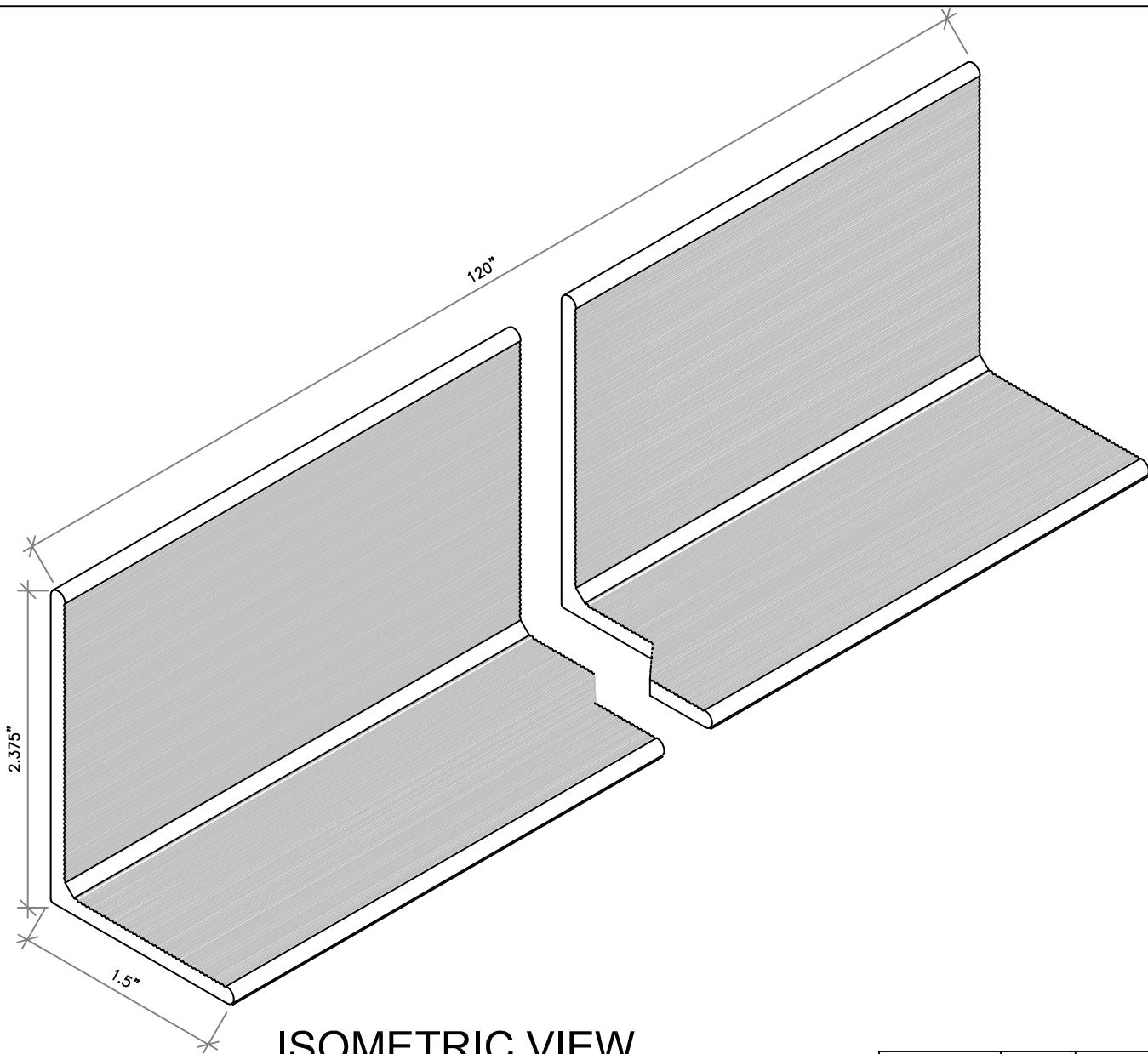

PROPRIETARY AND CONFIDENTIAL
 THE INFORMATION CONTAINED IN THIS DRAWING IS THE SOLE PROPERTY OF MONARCH METAL FABRICATION. ANY REPRODUCTION IN PART OR AS A WHOLE WITHOUT THE WRITTEN PERMISSION OF MONARCH METAL FABRICATION IS PROHIBITED.

MATERIAL 6061-T6
 FINISH Black Powder Coated
 DO NOT SCALE DRAWING

	NAME	DATE
DRAWN	GURU	25/10/19
CHECKED	BB	
COMMENTS:		
-		

TITLE: L Rail - 2.375"		
SIZE A	DWG. NO. L Rail - 2.375"	REV A
SCALE: 1:1	WEIGHT:	SHEET 1 OF 1

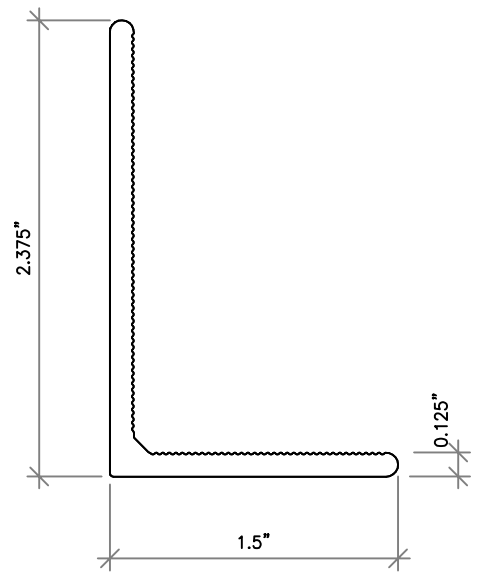
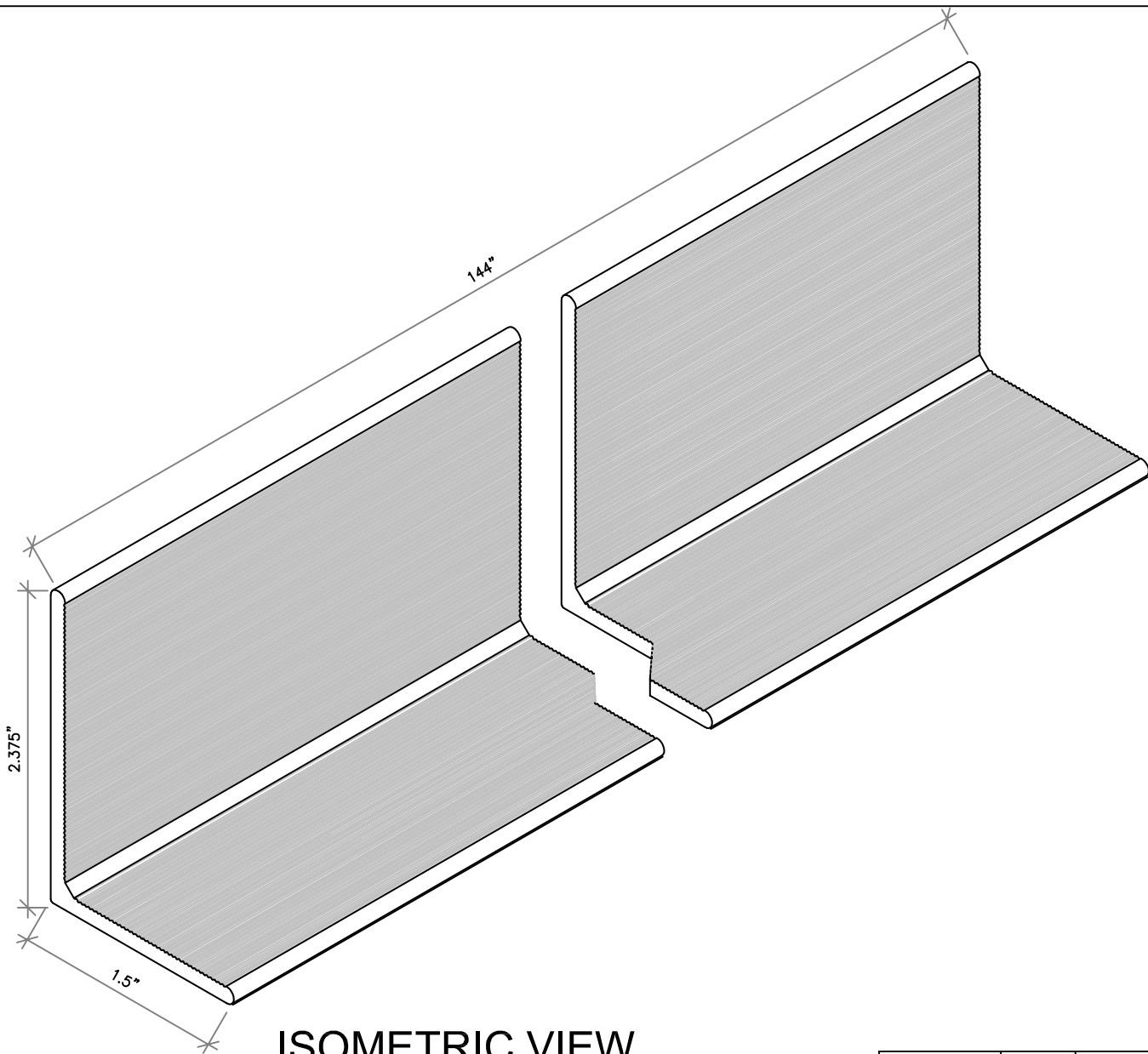

ISOMETRIC VIEW



PROPRIETARY AND CONFIDENTIAL
 THE INFORMATION CONTAINED IN THIS DRAWING IS THE SOLE PROPERTY OF MONARCH METAL FABRICATION. ANY REPRODUCTION IN PART OR AS A WHOLE WITHOUT THE WRITTEN PERMISSION OF MONARCH METAL FABRICATION IS PROHIBITED.

MATERIAL 6061-T6
 FINISH Black Powder Coated
 DO NOT SCALE DRAWING

	NAME	DATE
DRAWN	GURU	29/10/19
CHECKED	BB	
COMMENTS:	-	

TITLE: L Rail - 2.375" L=144"		
SIZE A	DWG. NO. L Rail - 2.375",L=144"	REV A
SCALE: 1:1	WEIGHT:	SHEET 1 OF 1